

VIDA DESIGN ASSISTANT

BY ASR DESIGN STUDIO

WWW.ASRDESIGNSTUDIO.COM/VIDA

HELPING YOU BEHIND THE SCENES

claim your time back

Let's Collaborate Together

hey boss babe,

We are so excited for the opportunity to collaborate with you and bring your design visions to life. In this packet you will find a variety of projects, looking for something specific, please ask us as we can not feature all of our work.

Our goal is to be an extension of your design firm when you need us. We work hard to ensure that the end result meets your requirements and you are able to win over your clients and contractors with a professional set of drawings.

If you have any questions, please don't hesitate to reach out. We look forward to working with you.

XOXO,

Ariel Richardson
Founder + Interior Designer

your design bestie



SKETCHUP MODEL + SCREEN SHOTS



your design bestie

MEDIUM QUALITY RENDERINGS



your design bestie

HIGH QUALITY RENDERINGS

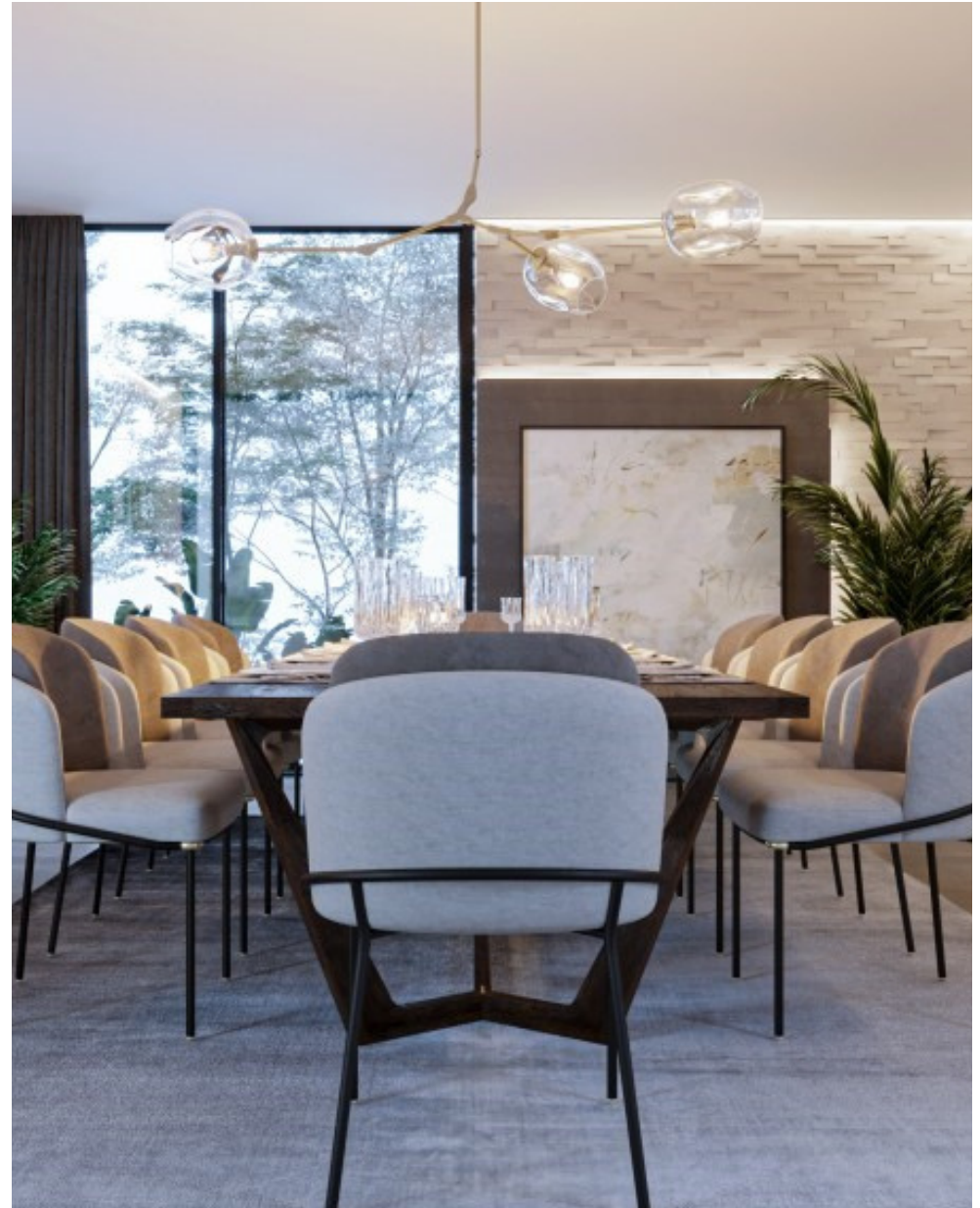

your design bestie

EXTERIOR HIGH QUALITY RENDERINGS



your design bestie

EXTERIOR HIGH QUALITY RENDERINGS



your design bestie

EXTERIOR HIGH QUALITY RENDERINGS



your design bestie

PROJECT ONE

13,000 SF Home Remodel

Collaborating with Designer for Preliminary Design Development in order to get their client excited about their upcoming remodel.

- Kitchen Space Planning Development
- Coffee + Adult Bar Design Development
- Kitchen Closed Uppers vs Floating Shelves

Programs Used

- AutoCAD
- SketchUp

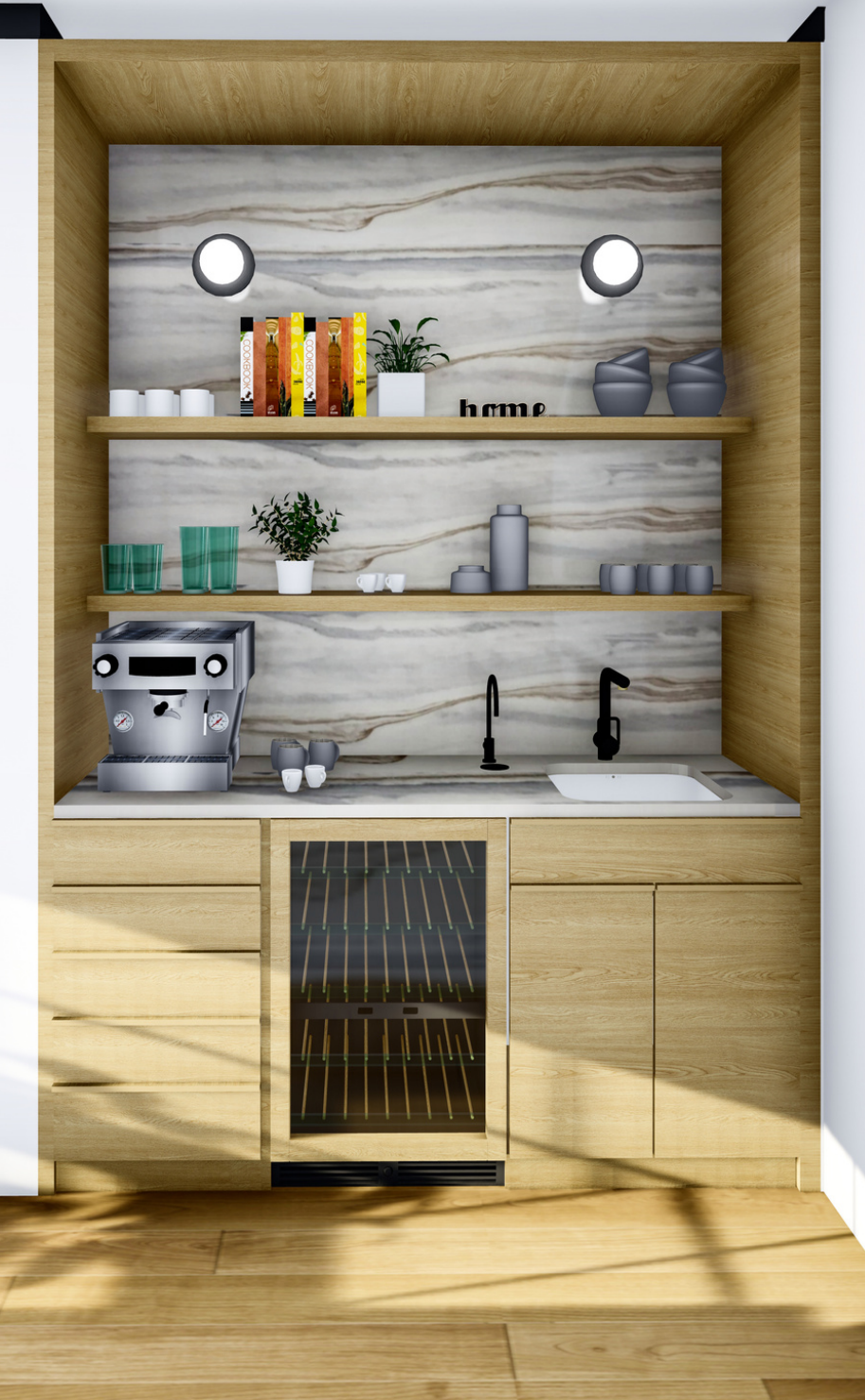

your design bestie

PROJECT ONE

Floor Plans + SketchUp

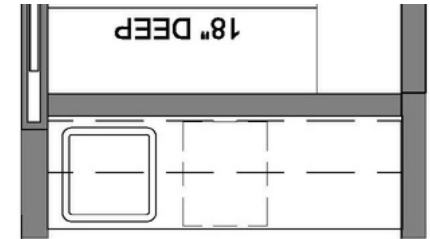
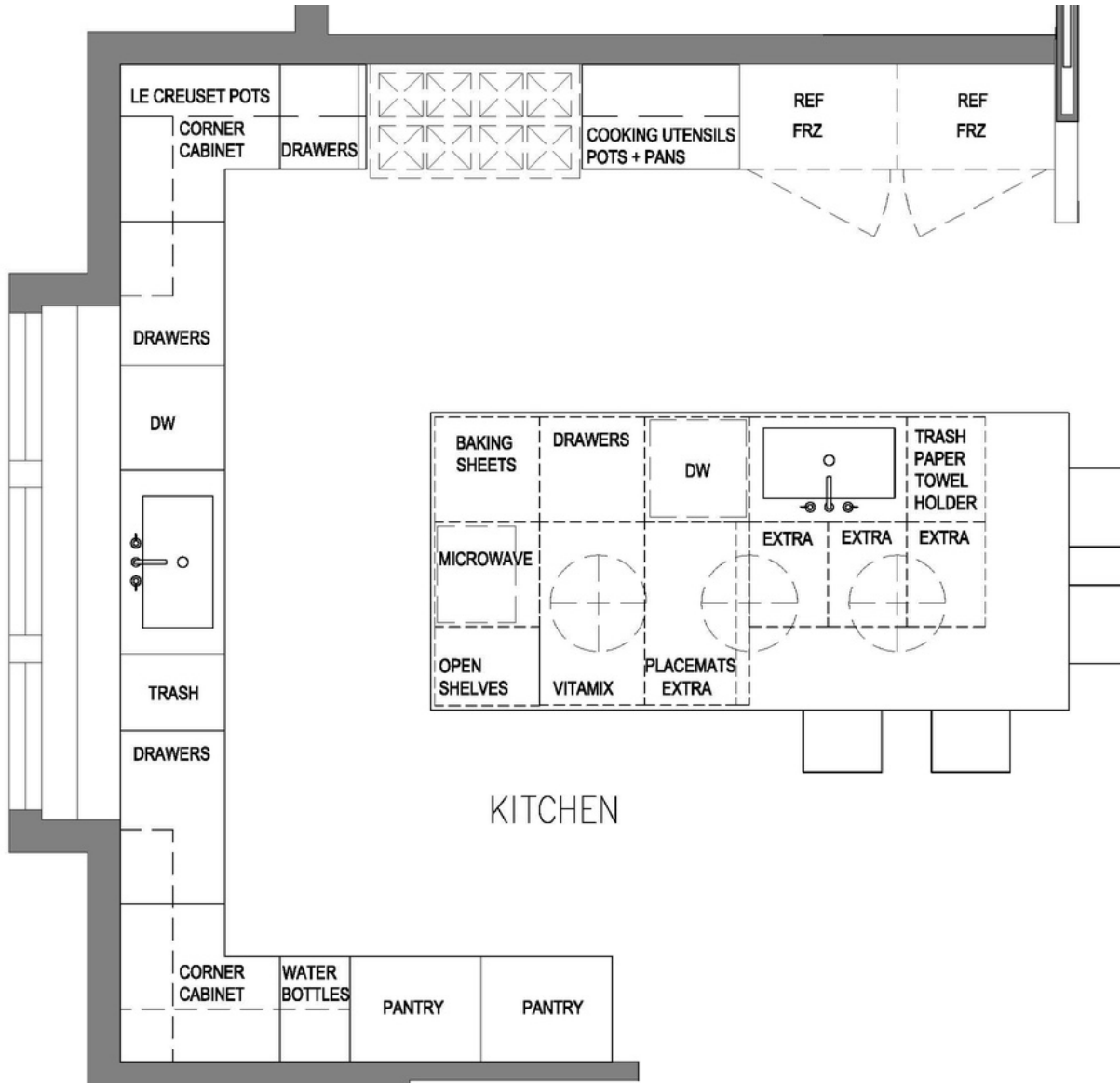

COFFEE BAR

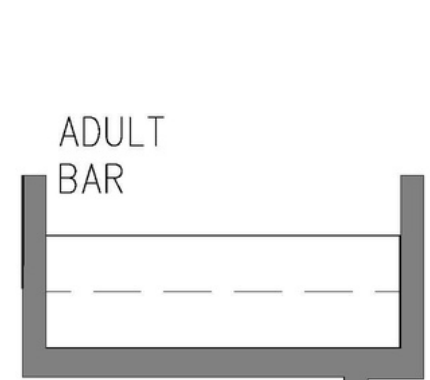

ADULT BAR

your design bestie



PROJECT ONE

Kitchen Renderings Lighting + Stool Options



your design bestie



PROJECT TWO

New Build

- 2 Story Home w/ Cabana
- 2 Kitchens, Living Room, Dining Room, Family Room, Office, 2 Kid Suites, Master Suite, Guest House (Cabana)
- All Finishes, Lighting, Furniture that was specified was placed into Floor Plans + Elevations for client approval and contractor build
- Furniture Layouts
- Elevations
- 6 Page CD set to integrate with Architectural Permit Set

Programs Used

- AutoCAD

your design bestie

PROJECT TWO
Main Floor Plan

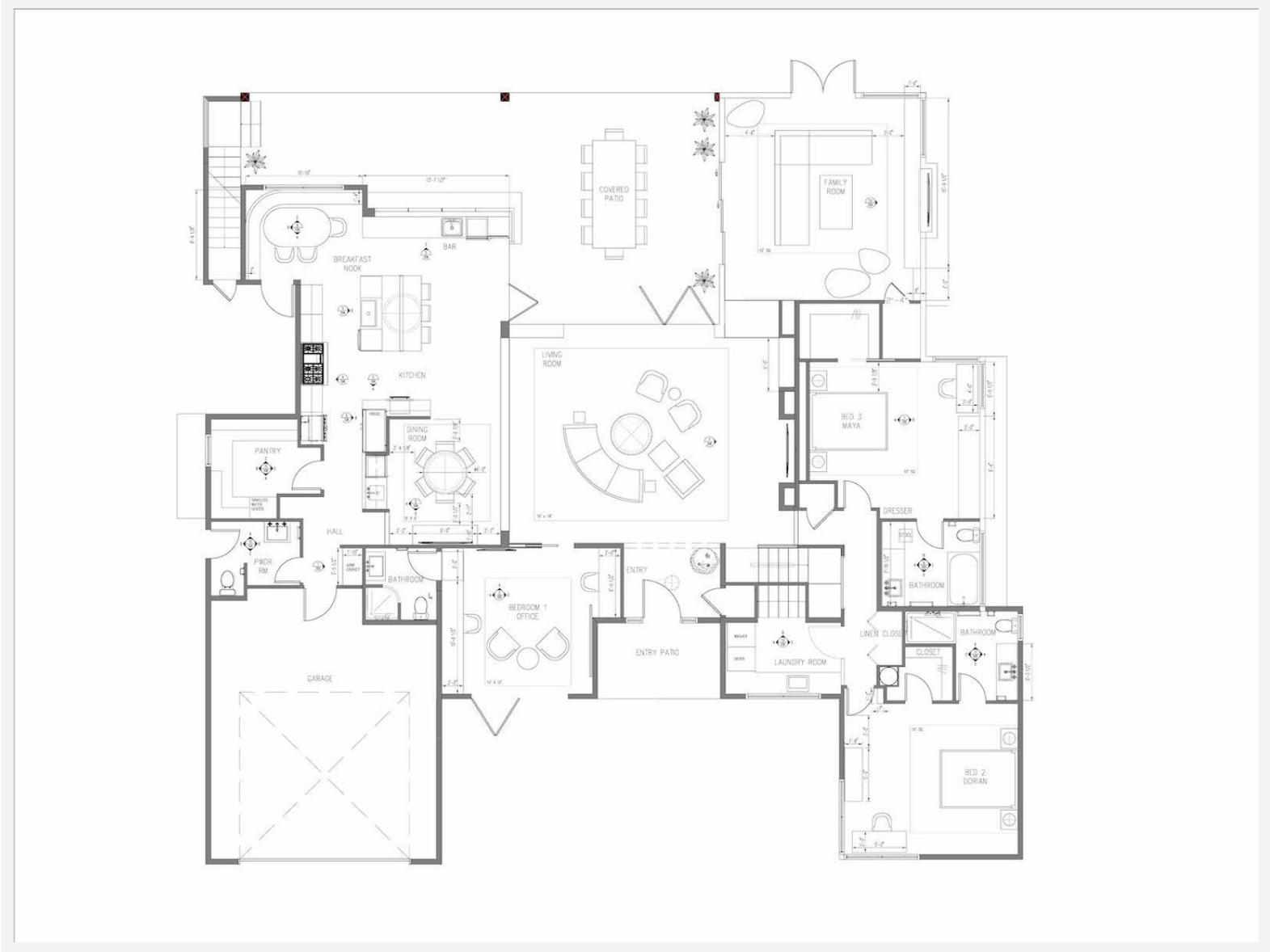

your design bestie

PROJECT TWO

CD Set: Elevations

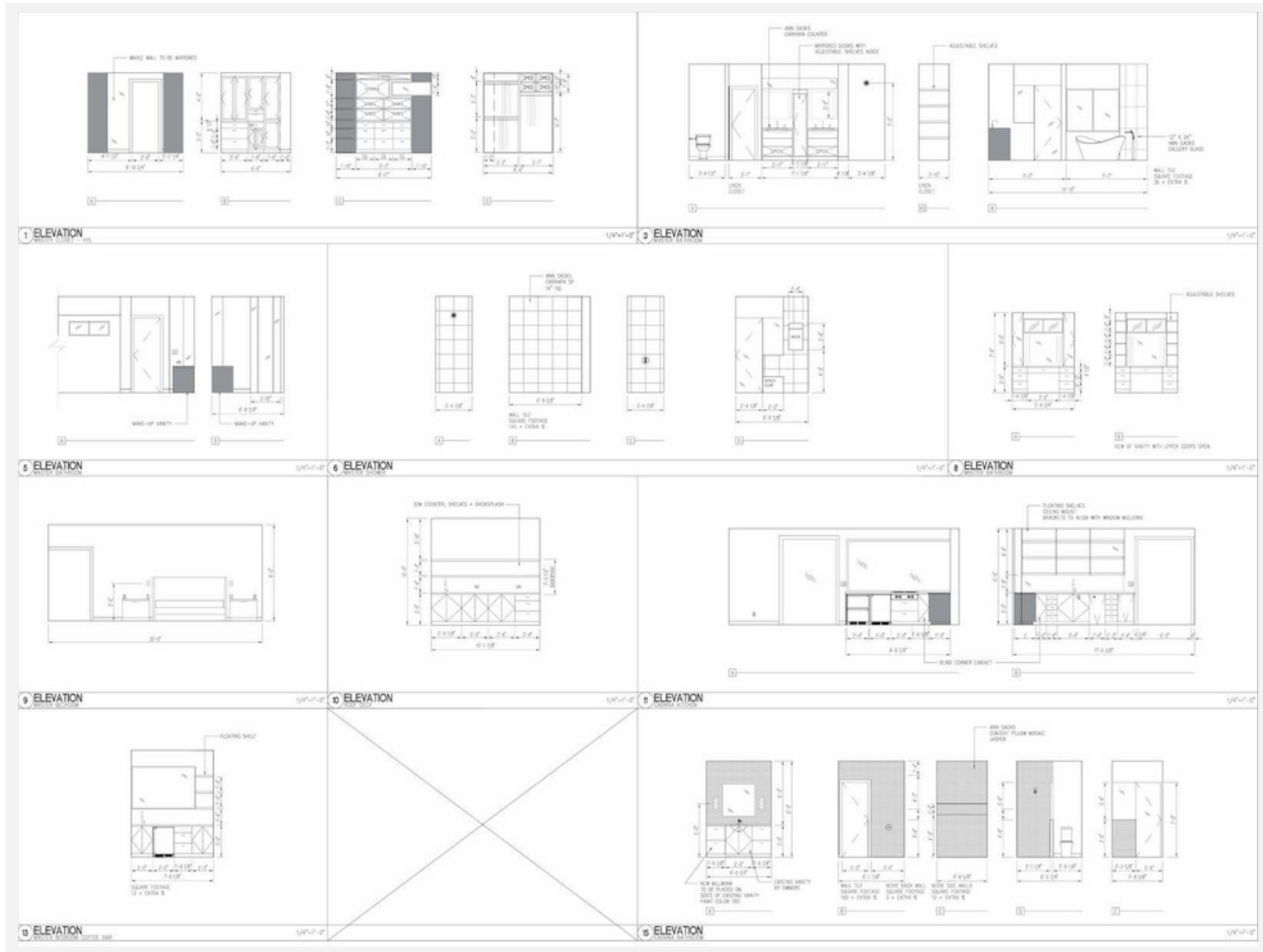

your design bestie

PROJECT THREE

Kitchen Remodel

- Floor Plan
- Elevations
- 3D Model

Programs

- AutoCAD
- SketchUp

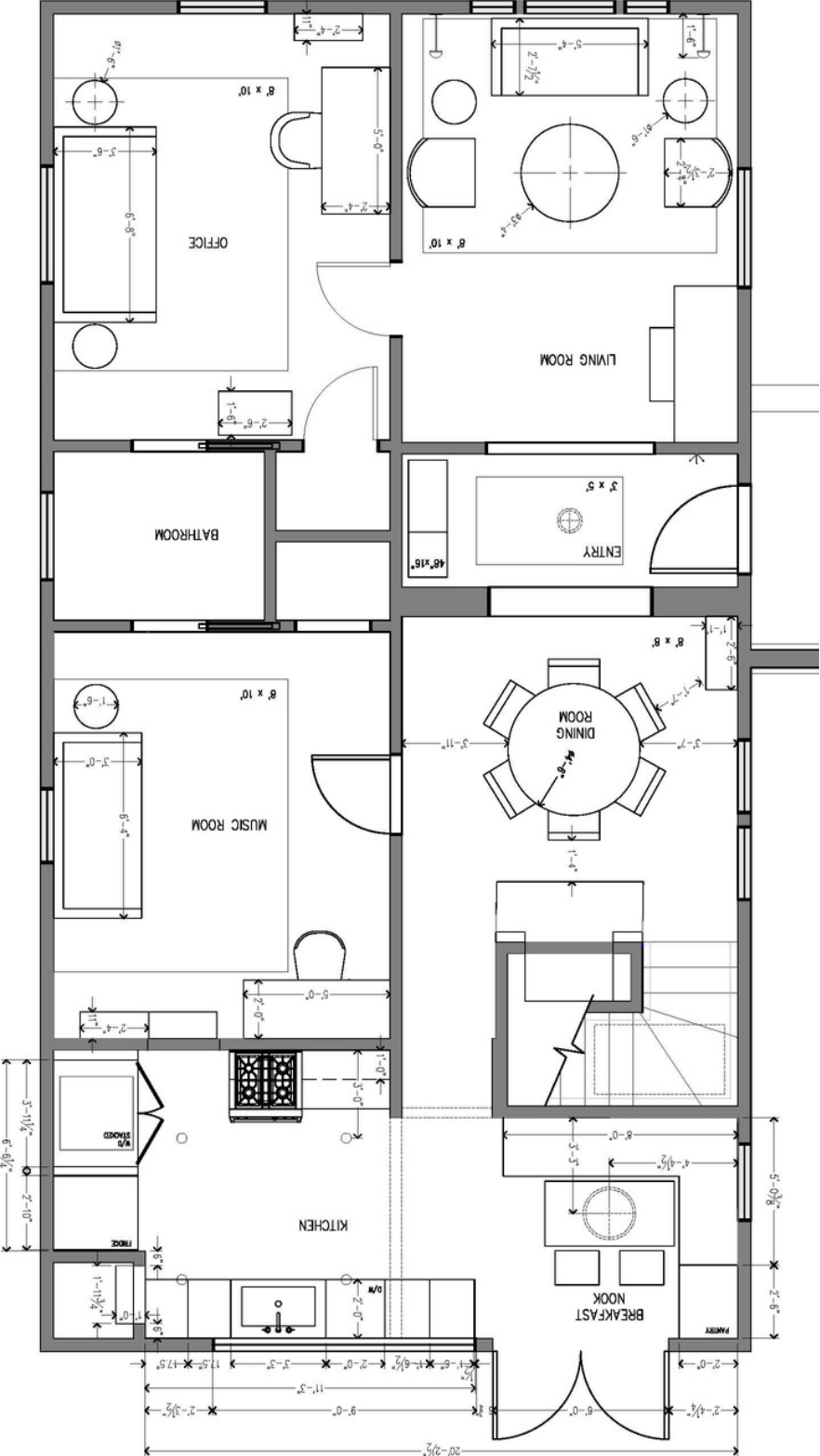

your design bestie

PROJECT THREE
Elevations

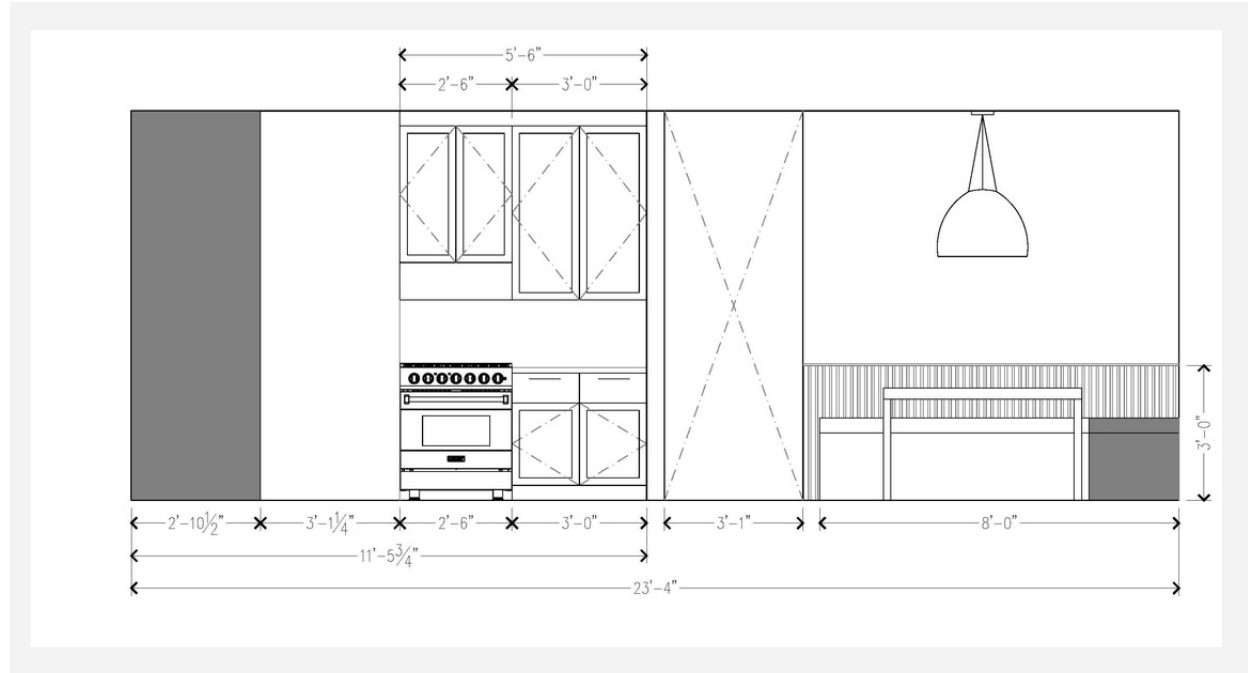
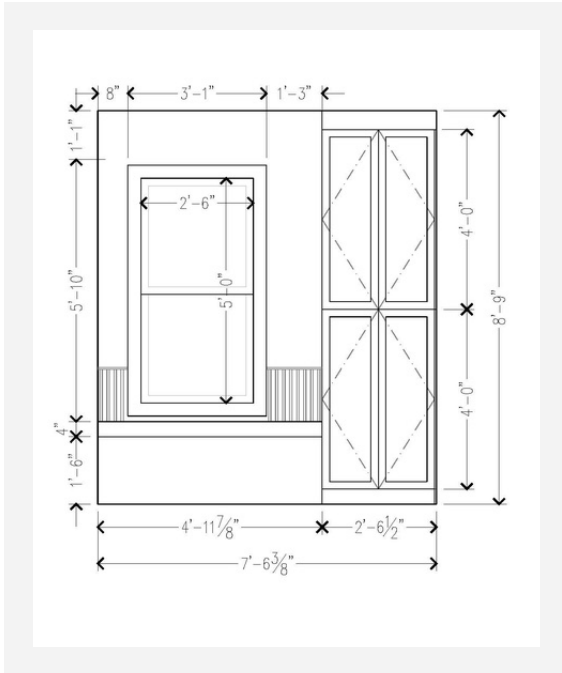
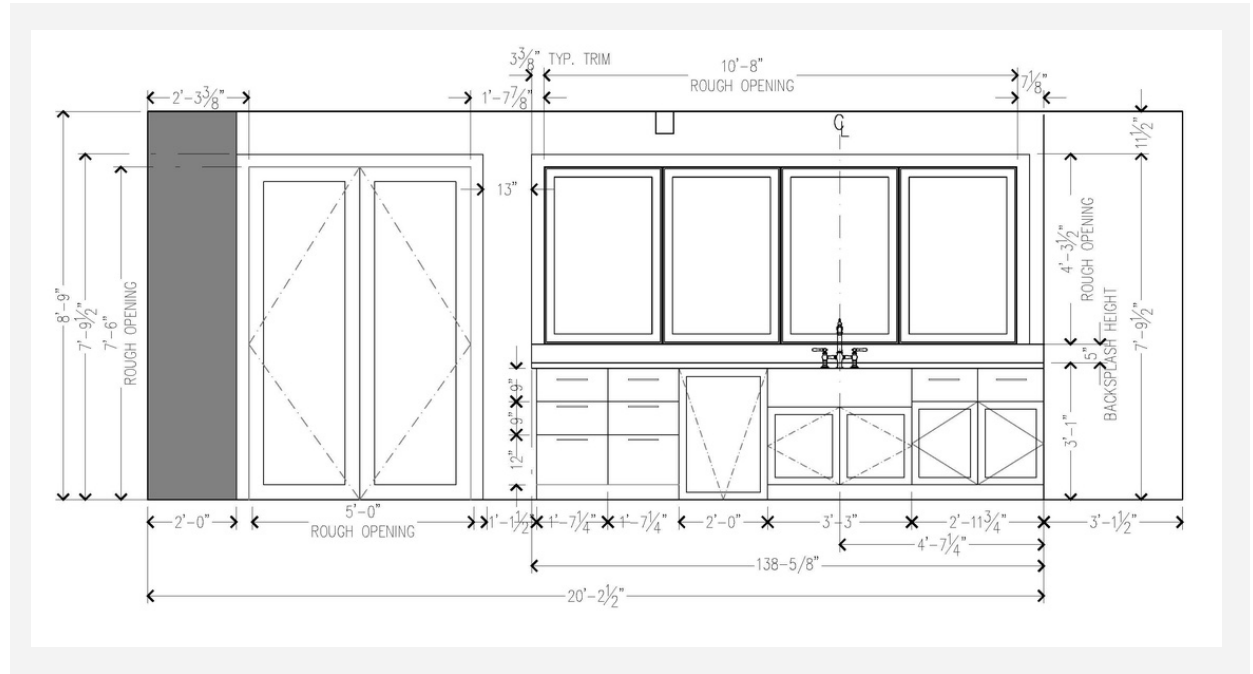

your design bestie

PROJECT THREE

Sketch Up Screen Shots



SketchUp Model: Kitchen



SketchUp Model: Breakfast Nook



SketchUp Model: Living Room

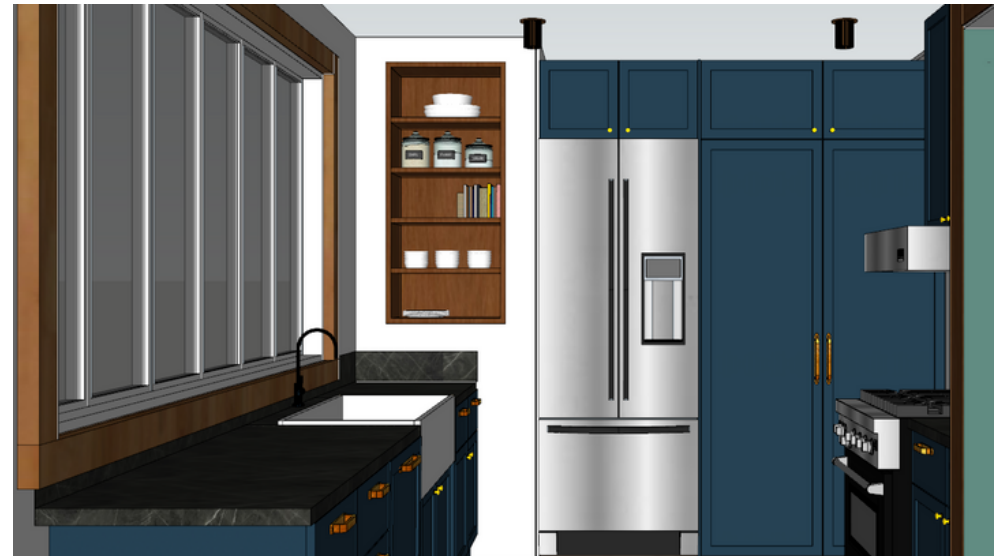

SketchUp Model: Kitchen



PROJECT FOUR

Nursery

- Renderings
- Completed Project Portfolio Images

Programs

- SketchUp

your design bestie

PROJECT FOUR



Portfolio Image



Portfolio Image



Rendering

your design bestie

PROJECT FOUR



Portfolio Image



Rendering



Rendering

your design bestie



photography @maxm50

PROJECT FIVE

Kitchen Remodel

- Floor Plan
- Kitchen Elevations
- Completed Project Portfolio Images

Programs Used

- AutoCAD

your design bestie

PROJECT FIVE

Elevations



photography @maxm50

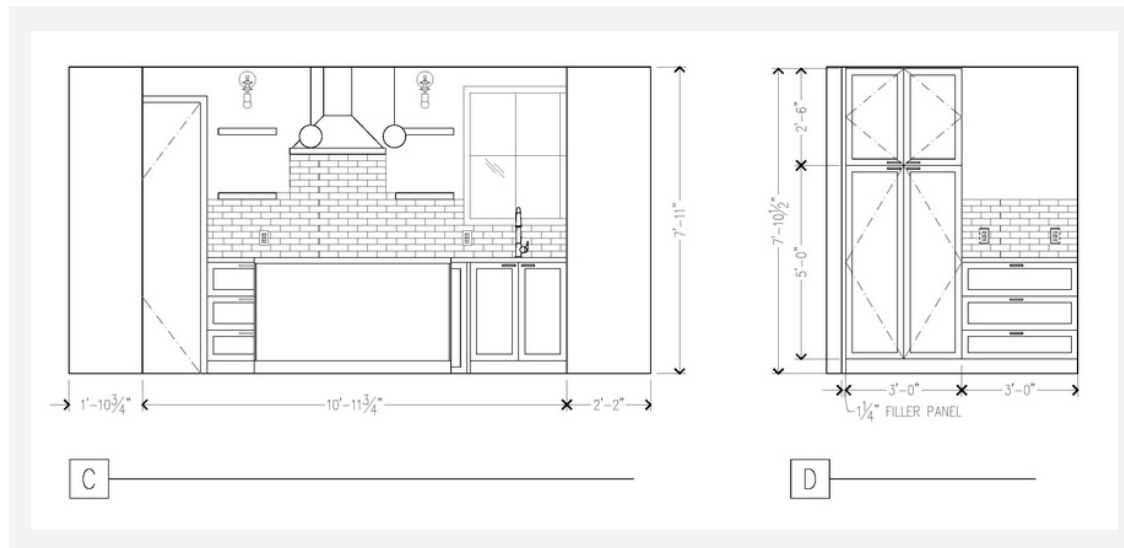

your design bestie

PROJECT FIVE

Elevations

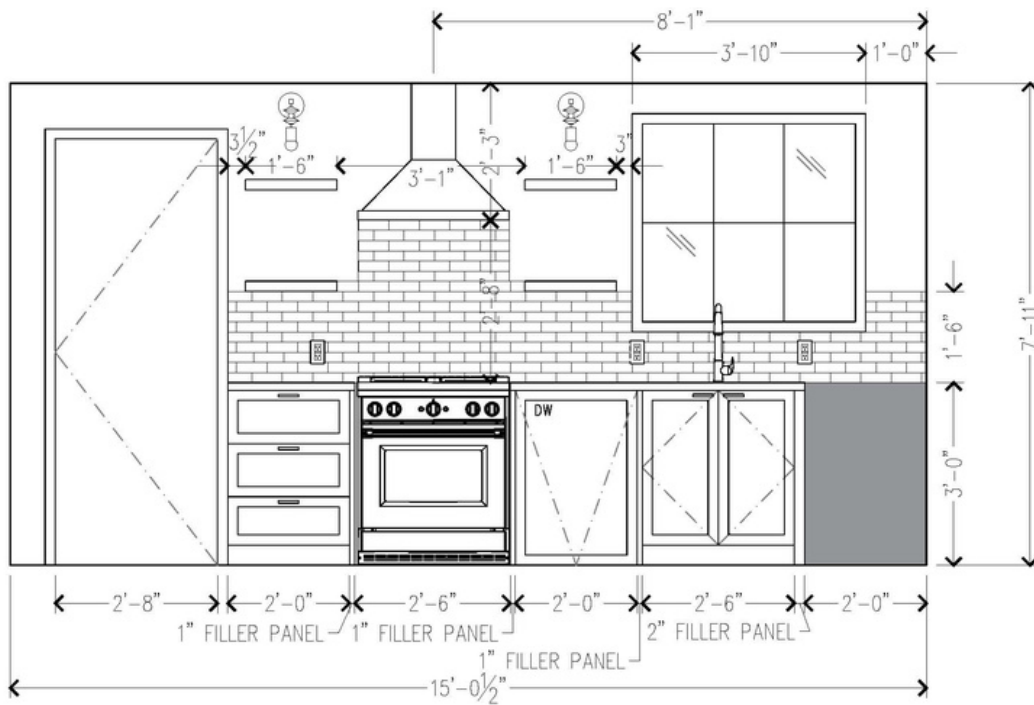

A

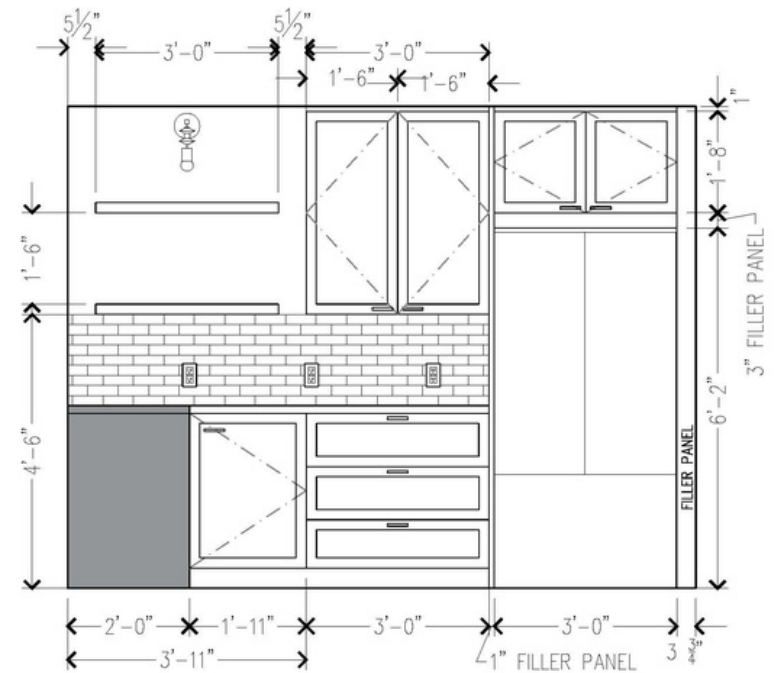

B

your design bestie

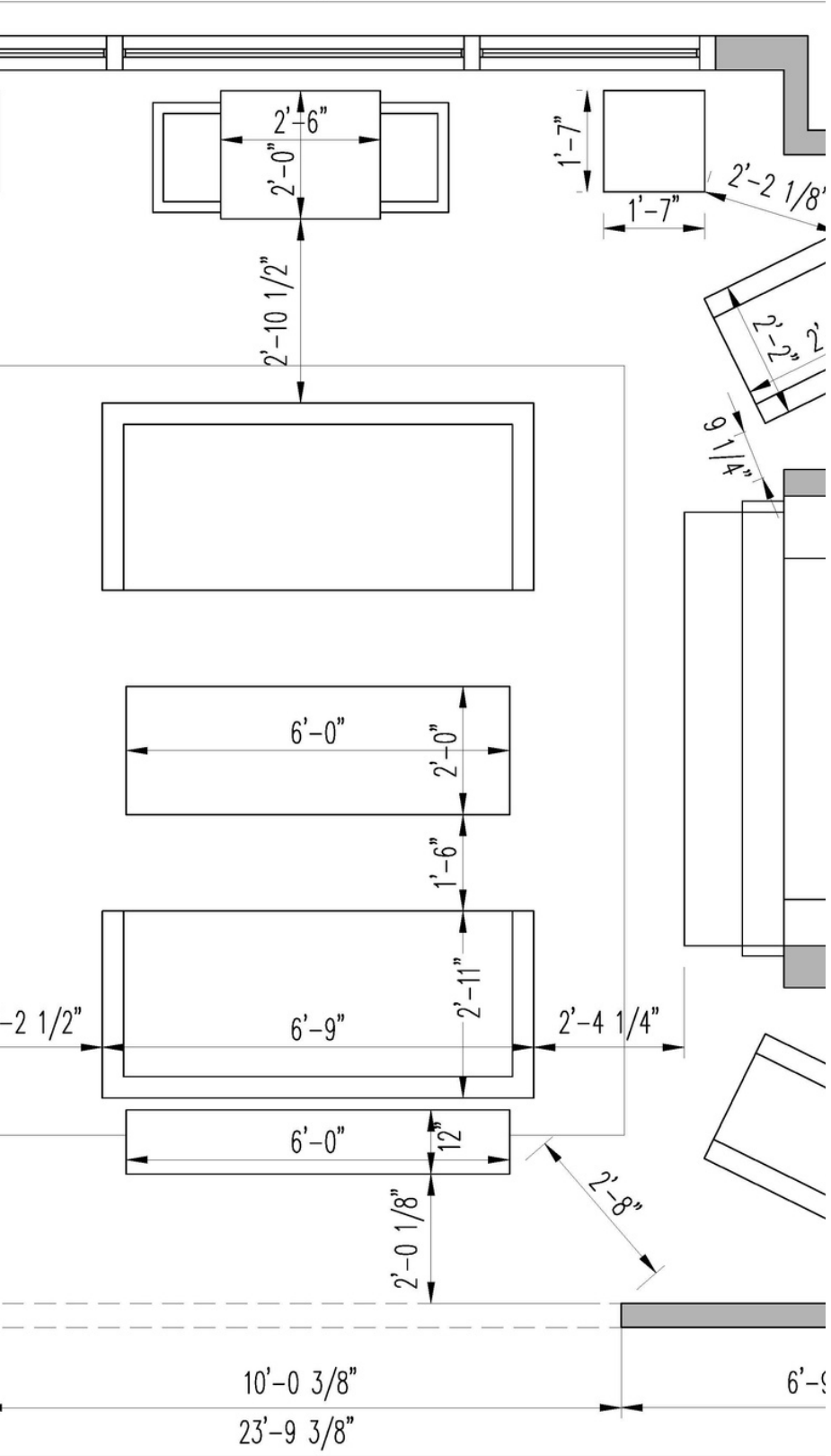

PROJECT SIX

Furniture Layouts

- Bedrooms
- Living Rooms
- Front Porch

Programs Used

- AutoCAD

your design bestie

PROJECT SIX

Floor Plans

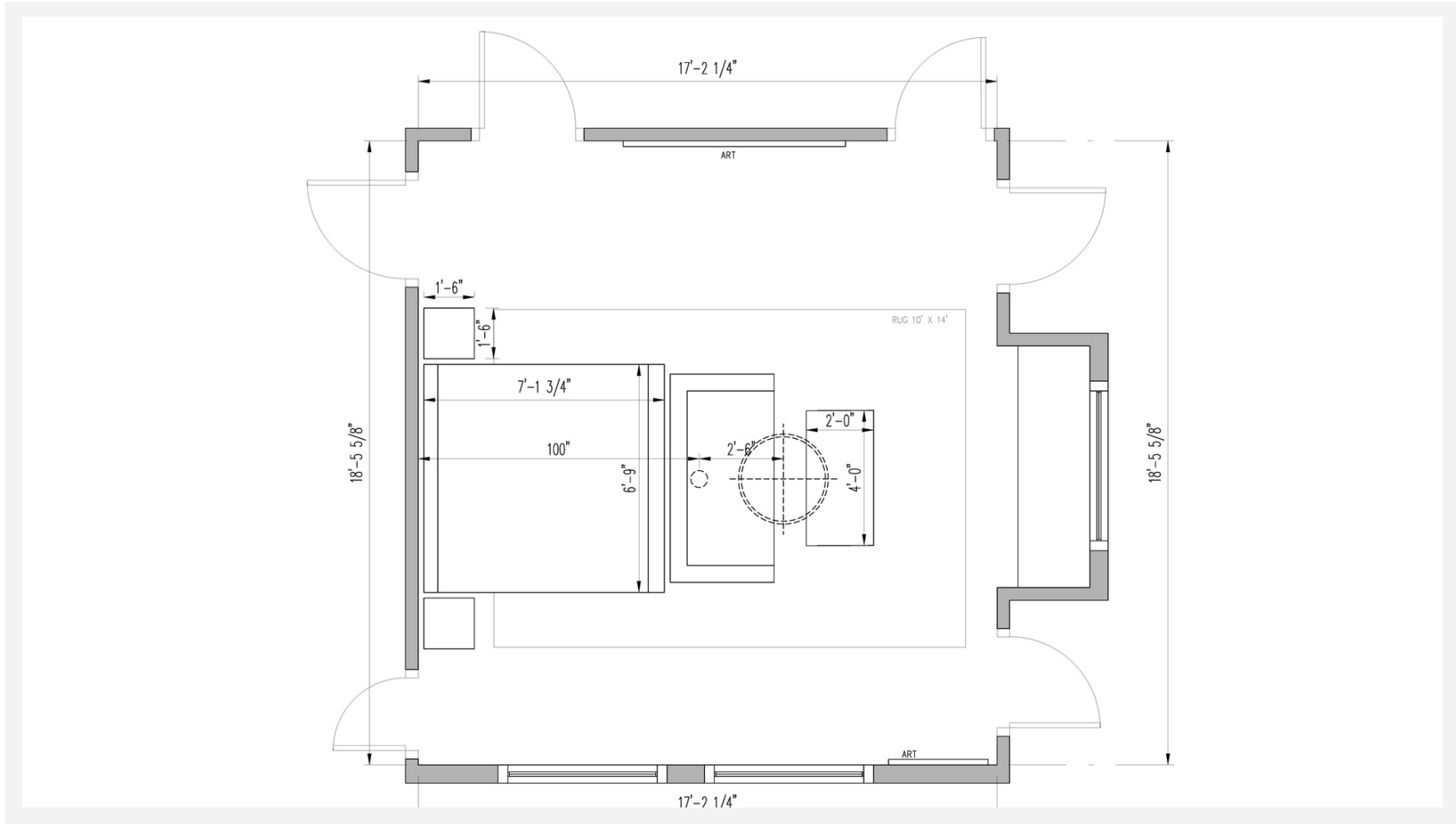

Master Bedroom Furniture Plan

your design bestie

PROJECT SIX

Floor Plans

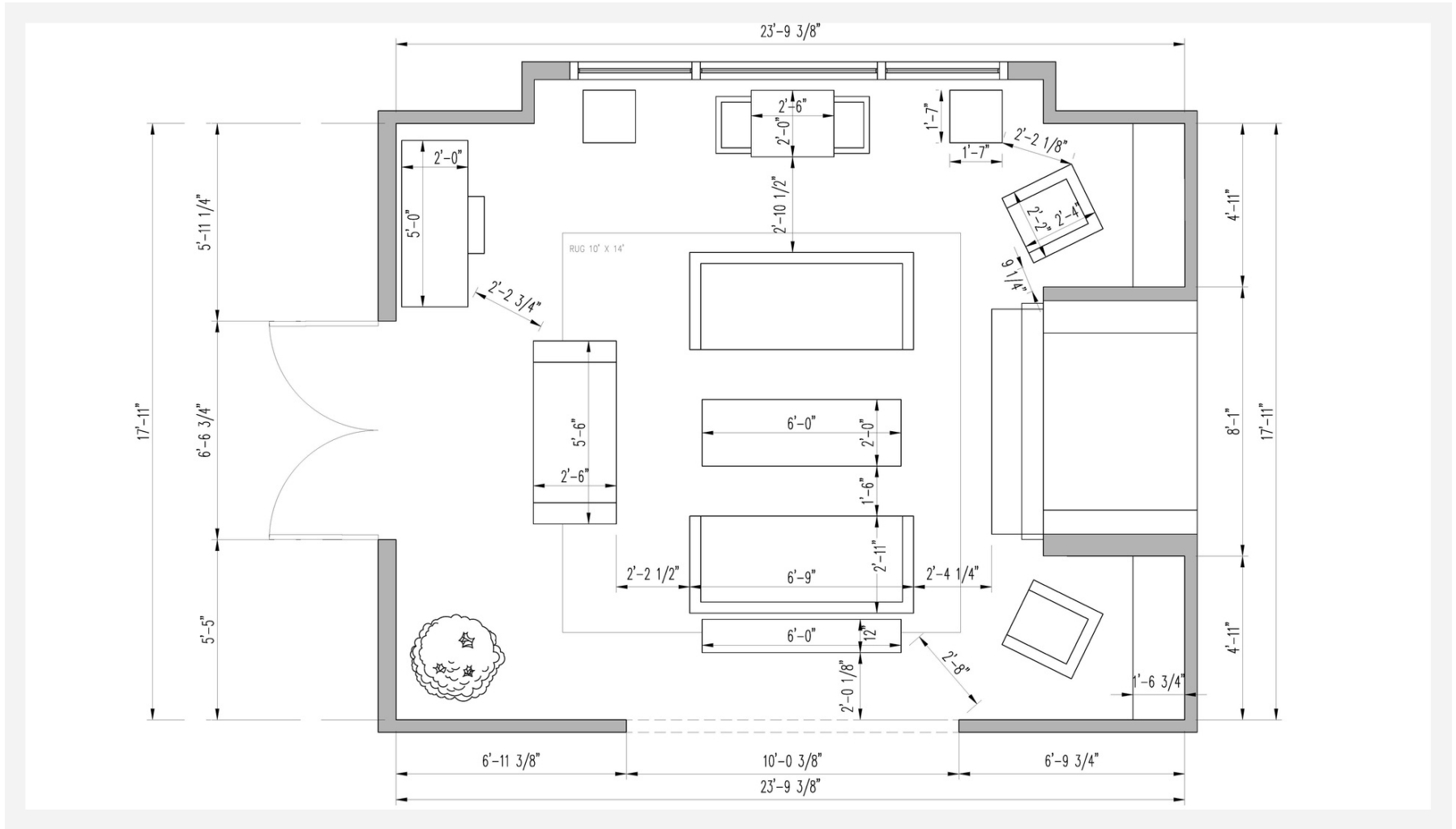

Living Room Furniture Plan

your design bestie

PROJECT SIX

Floor Plans

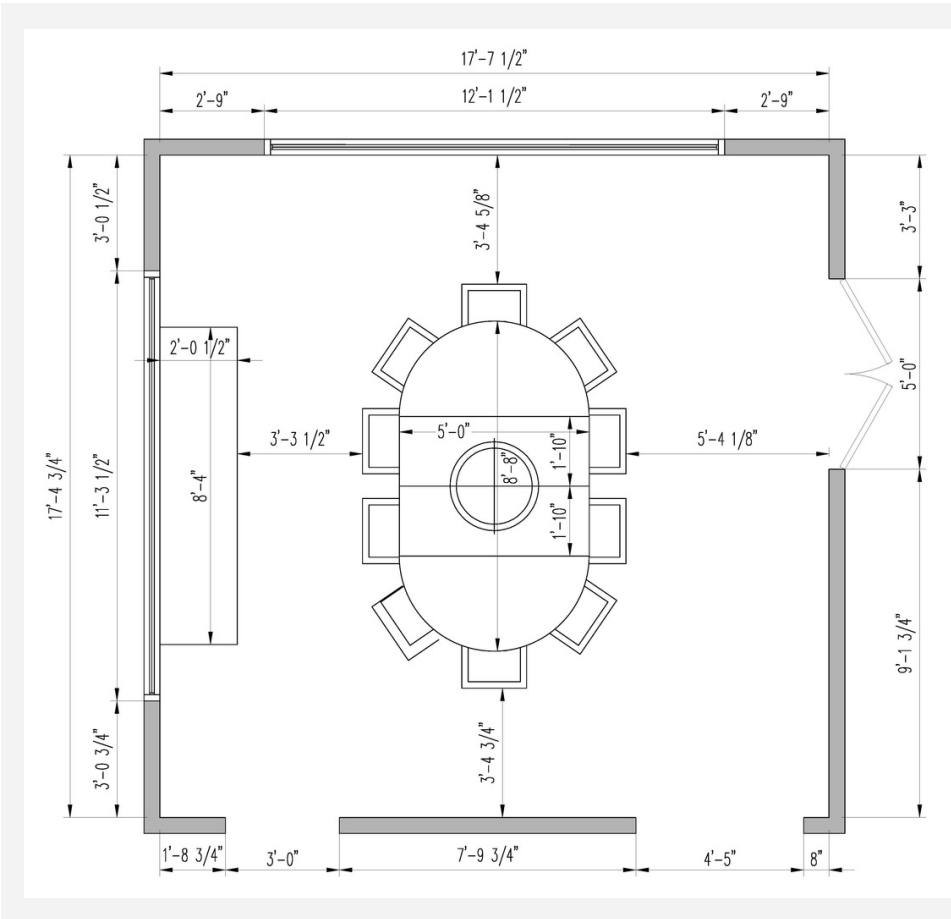

Dining Room Furniture Plan

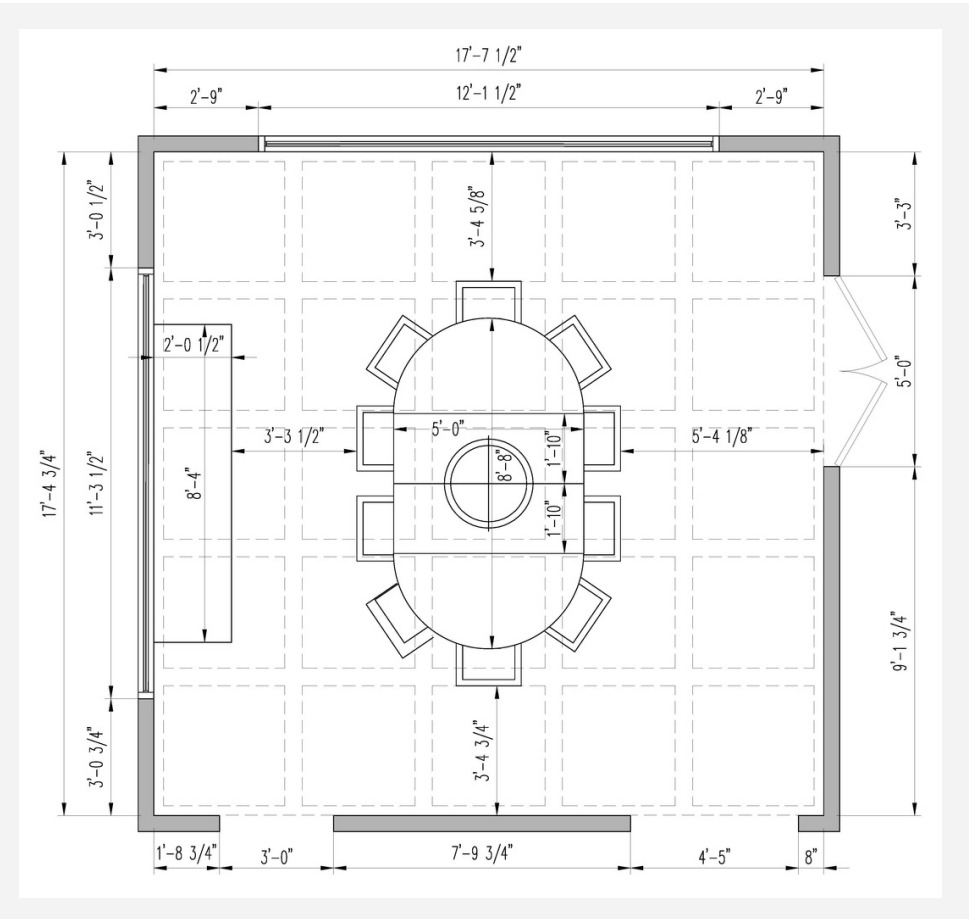

Dining Room Furniture Plan w/ Ceiling Details

your design bestie



Thank you

FOR CHOOSING
VIDA BY ASR DESIGN STUDIO

Please feel free to contact us with any questions.

Ariel Richardson
Founder + Interior Designer
projects@asrdesignstudio.com
510.545.9425